



**FACADE PANELS  
SOLVO**

# SOLVO FACADE PANELS

Solvo are modern hollow panels, perfect for finishing facades. They are characterized by a light yet rigid structure, making installation quick and simple, while ensuring an aesthetic effect in a short time. Solvo is available in 3 shapes, which differ in the width of the slats. Their refined shape ensures precise panel connections and translates into an elegant appearance of the façade on the wall. The panels are durable and resistant to temperature fluctuations. They require no maintenance and are easy to clean. Even after many years of use, they will still look beautiful. Additionally, they can be 100% recycled.



CEDAR, SO-02

# DISCOVER A WORLD OF POSSIBILITIES



CHOCOLATE OAK, SO-02 & SO-03



NATURAL OAK V-BLACK, SO-01

By selecting the appropriate shape, colour of wood-like veneer or the type of finishing (with or without black grooves) you can achieve various visual effects.

Installing the panels vertically or horizontally further influences the final appearance of the facade.

Solvo panels were a perfect solution for various types of buildings, including small constructions, such as extensions or mobile homes.



GREY OAK V-BLACK, SO-01

## 3D EFFECT

There are two versions of panels, each allowing for slightly different visual effects. Both give the facade a 3D appearance, enabling the play of light and shadow on the surface. The version with black grooves enhance the three-dimensional effect even more, giving the façade additional depth.

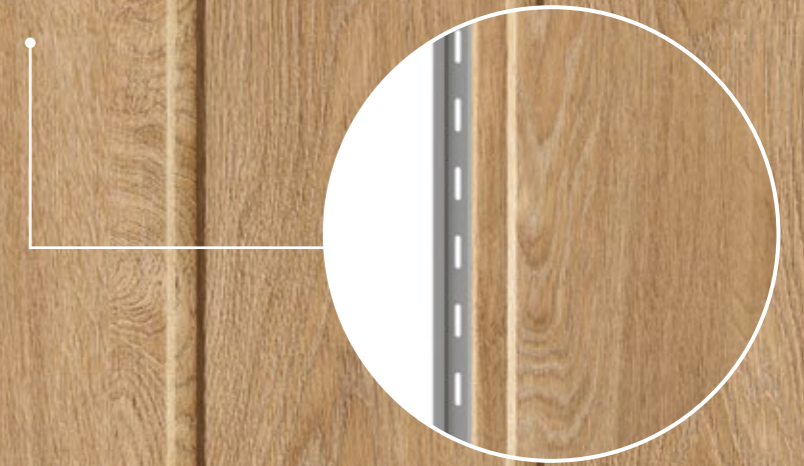
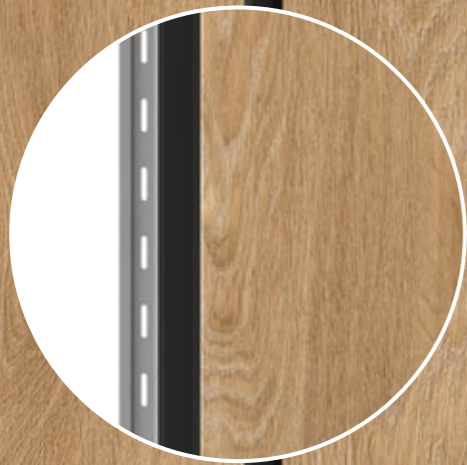

# ONE SIZE THREE SHAPES

Two new Solvo shapes mean twice as many possibilities to make the facade look truly exceptional. Mixing shapes or panel versions with and without joints allows you to arrange each wall in an interesting and unique way.



CHOCOLATE OAK, S0-02 & S0-03

## SO-01 V-BLACK COLOURS



CEDAR V-BLACK



NATURAL OAK V-BLACK



CHOCOLATE OAK V-BLACK



GREY OAK V-BLACK

## SO-01 STANDARD COLOURS



CEDAR



NATURAL OAK



CHOCOLATE OAK



GREY OAK



GREY OAK V-BLACK, SO-01

## SO-02 V-BLACK COLOURS



CEDAR V-BLACK



NATURAL OAK V-BLACK



CHOCOLATE OAK V-BLACK



GREY OAK V-BLACK

## SO-02 STANDARD COLOURS



CEDAR



NATURAL OAK



CHOCOLATE OAK



GREY OAK



CHOCOLATE OAK V-BLACK, SO-02

## SO-03 V-BLACK COLOURS



CEDAR V-BLACK



NATURAL OAK V-BLACK



CHOCOLATE OAK V-BLACK



GREY OAK V-BLACK

## SO-03 STANDARD COLOURS



CEDAR



NATURAL OAK



CHOCOLATE OAK



GREY OAK



CEDAR, SO-03



# SMART SOLUTIONS

## MOUNTING HOLES

Pre-drilled mounting holes make installation quick and easy.

## CHAMBER STRUCTURE OF THE PANEL

The chamber structure of the boards makes them exceptionally strong and stable while being relatively light.

## FOILED SURFACE

Surface covered with high-quality foils with a delicate brushed-wood texture.

## ELEGANT SHAPE

The harmonious line of the panels, from the shape of the edges to the depth of the grooves, enhances their elegant design.



### DESIGN

Modern look of the board shape.  
Reflection of the colour and grains of wood.  
Two options to choose from – with the black groove or without



### ARRANGEMENT POSSIBILITIES

The panels can be mounted horizontally or vertically



### WATER RESISTANCE

Panels and finishes are waterproof



### MAINTANCE FREE

Does not require maintenance, which is time-consuming and expensive



### DURABILITY

The facade is resistant to mechanical damage.  
Impact strength above 10 GJ



### EASY INSTALLATION

The lightness and stiffness of the panels and 2-piece finishing trims guarantee problem-free installation



### GUARANTEE

Guaranteed trouble-free use for years



### RECYCLING

100% recyclable product

# THINKING ABOUT NATURE

Taking care of the environment is our common duty – both on an individual and business level. When creating the VOX offer, we analyze the production opportunities on an ongoing basis, and we make every effort to ensure that the carbon footprint that we leave in the ecosystem is as low as possible. Modern technological lines, the use of high-quality raw materials, recipes improved over the years and well thought-out design of the products themselves allow to maintain their excellent technical parameters and functionality.

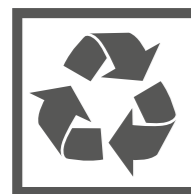

## RECYCLING

Solvo panels and all dedicated finishings are 100% recyclable.



## DURABILITY

The durability and resistance to damage of Solvo panels means that the façade will not require repair or replacement for many years. The guaranteed lifetime is 10 years.



## MAINTENANCE

There is no need for maintenance over the entire lifetime, and therefore no additional chemicals (paints, preservatives, etc.)

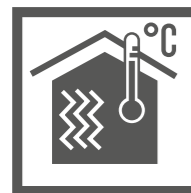

## INSULATION

The use of the Solvo ventilated façade ensures the proper functioning of the insulation layer and minimizes the risk of wall dampness and mould formation.



## HEALTH

Our products are safe for health and do not contain harmful substances. No lead, cadmium, barium or other heavy metal compounds are used in the production process.

# SUSTAINABLE DEVELOPMENT POLICY

## WE KEEP OUR PROMISES: CUSTOMERS APPRECIATE OUR SERVICE



We want customers to appreciate our quality of service. At each stage of our work, we ask whether our action brings added value to the client. Therefore, they took care of the details and nuances, so that the customer experience throughout the purchasing process was unique and built a positive image of our company for years. We keep our promises in every way. Starting with timely deliveries and quality standards, and ending with individual arrangements with customers. We do everything in our power to ensure that the quality of our products complies with the requirements. In the event of errors, we make every effort to ensure that the repair process is as short as possible and as customer-friendly as possible.

## WE WANT TO BE BETTER EVERY DAY



Each operating unit strives for process optimization every day. We are looking for small improvements, but also groundbreaking solutions. We are not afraid to experiment. We eliminate waste and optimize our costs. We are looking for modern technical and organizational solutions. We are ready for changes. Where possible, we act quickly and effectively. Where necessary, we act methodically and carefully. We want our infrastructure to change and be more and more modern every year. Our units are to be functional and efficient, but also to be our showcase.

## WE OPERATE IN A SAFE AND RESPONSIBLE MANNER



We all are responsible for shaping safety-oriented mindset. We have the responsibility to send our people back home to their families in good health and we ensure safety of the factory continuity. Need to be a responsible business, honest employer and good local neighbour, so by taking responsibility for social considerations, finance and the environment, always working for a sustainable future.

## WE ARE THE TEAM



Each of us is different and everyone has different needs. We strive to use this diversity as part of teamwork. The sum of the potentials and knowledge of team members determine its effectiveness and efficiency. That is why we try to develop both teamwork skills and our own competences. Respect and trust are the pillars of our cooperation. We help each other and solve problems together. Freedom is our basic value. Freedom for us is the opportunity to search and experiment. Freedom is the ability to argue and discuss freely. Freedom is the right to constructive criticism and feedback.

# TROUBLE-FREE INSTALLATION

## INSTALLATION POSSIBILITIES

The panels can be installed vertically or horizontally.

## MATCHING ACCESSORIES

All finishing trims are available in colours matching the panel decors.

## FAST AND CLEAN

The chamber structure of the board's makes them exceptionally strong and stable. That is why the installation is simple and quick. The boards are screwed to the standard metal or wooden structure using screws. The pre-punched mounting holes and comfortable 2-piece finishing trims greatly reduce installation time. The installation is clean with no dust during processing.



SCAN FOR  
INSTALLATION  
VIDEO



CEDAR, S0-01

# SYSTEM ELEMENTS

**S0-01**  
Single panel

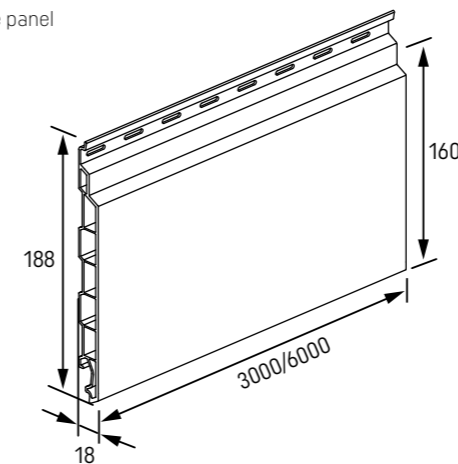

**S0-02**  
Double panel

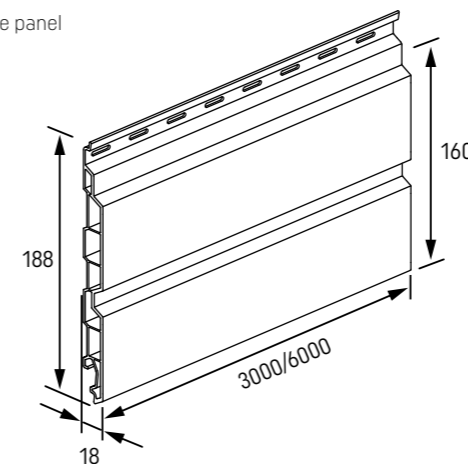

**S0-03**  
Triple panel

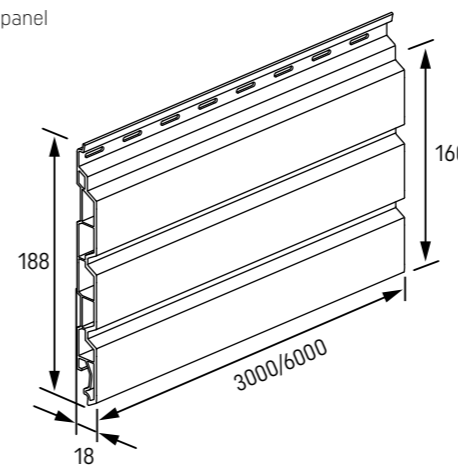

**FS-211**  
Starting trim

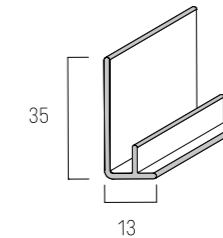

**FS-222**  
Outside corner (two-part)

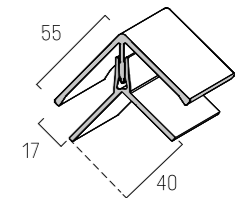

**FS-251**  
Universal trim U

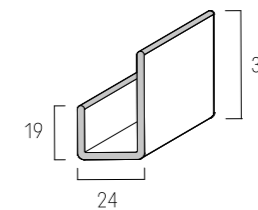

**FS-252**  
Top edge trim (two-part)

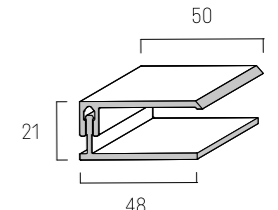

**FS-261**  
Perforated trim

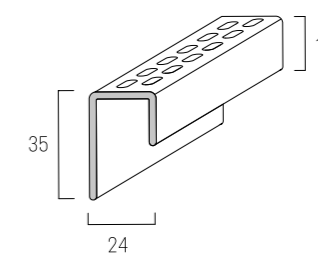

**FS-262**  
Ventilation trim (two-part)

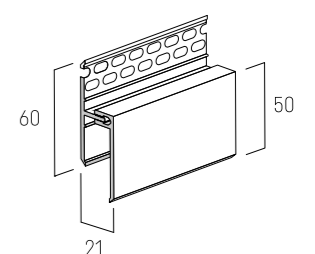

**FS-282**  
Center joint trim (two-part)

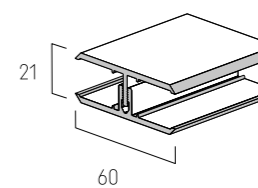



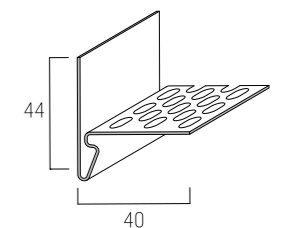









**FS-11.5**  
Bottom ventilation trim



# PRODUCT FEATURES

GREY OAK, SO-01

FEATURE	NORM	TEST RESULT	UNIT
 Area density		SO-01 - 130 SO-02 - 132 SO-03 - 136	kg/lm
 Impact resistance	PN-EN 13245-1:2010	Not less than 10J (23,10)	J
 Reaction to fire Self extinguishing properties	PN-EN 13501-1:2019-02	D-s3; d2	
 Does not contain harmful substances		NPD	
 Resistance to UV rays Colour resistance	PN-EN 20105-A02:1996 PN-EN 13245-2:2009/ AC:2010	< 3 in grayscale A.10.60	grayscale grade
 Resistance to changing weather conditions			
 Water resistance			
 Insects proof			
 Quick installation Thanks to the lightness and stiffness of the panels, built-in mounting holes and two-part finishing strips, the installation of Solvo is quick and uncomplicated			
 Maintenance free No need for painting and other treatment			
 Easy to keep clean Can be clean with water and mild detergents			
 100% recyclable			
 10 years product guarantee			



The manufacturer reserves the right to change the colours, dimensions, and functions of the presented products. This catalogue is published for informational purposes only. The catalogue presents examples of patterns from the offer. Some items presented in the arrangement, photos are for decoration only and are not for sale. Copying and distribution of any materials contained in the catalogue without the written consent of the publisher is prohibited. The colours in the catalogue may differ from reality. All data contained in the catalogue are valid in the month when the catalogue is submitted for printing – March 2025.

