

# SLIM-TRES

## Lavabos monomando

Ref.:

**N**

Monomando lavabo

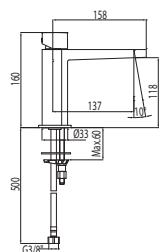
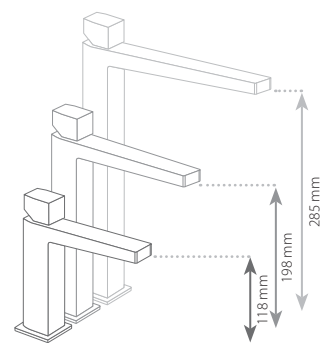

91.30.190



Cr

202.103.02

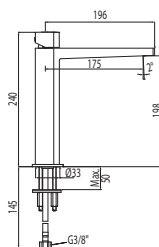

91.30.190



Cr

202.103.02.D

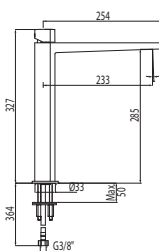

91.30.190



Cr

202.103.06



Cr = Cromo



Recomendado montar válvula SIMPLE RAPID (NO INCLUIDA)

Ref.:  

**N**

Monomando lavabo

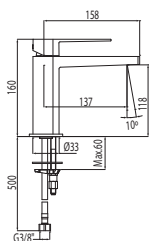

91.30.190

Cr

202.103.01



91.30.190

Cr

202.103.01.D

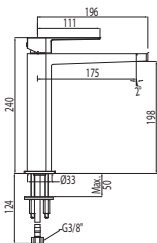

91.30.190

Cr

202.103.03

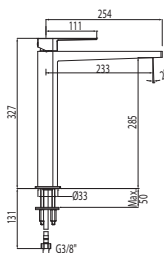

91.30.190

Cr

202.103.05



Cr = Cromo



Recomendado montar válvula SIMPLE RAPID (NO INCLUIDA)

# SLIM-TRES

Ref.:

**N**

**Monomando lavabo**  
con caño cascada libre

\* NOTA: La grifería con caño cascada se acompaña con 2 llaves de regulación con filtro (Ref: 91.34.525)

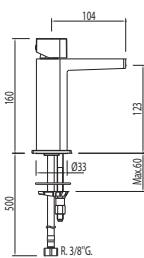

91.30.190

Cr 202.110.02

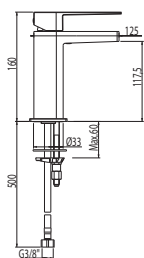

91.30.190

Cr 202.110.01

**N**

**Monomando mural**

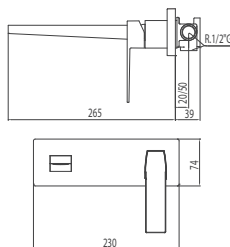

91.30.190

Cr 202.200.01

**Grifo lavabo 1 agua**

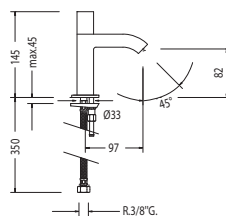

91.08.295.10

Cr 1.07.503

**Bidé**

Ref.:



Monomando bidé

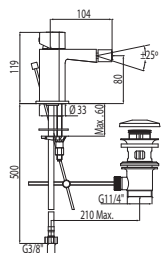

91.30.190

Cr

202.120.02



91.30.190

Cr

202.120.02.D



Monomando bidé

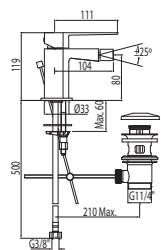

91.30.190

Cr

202.120.01



91.30.190

Cr

202.120.01.D



Monomando bidé

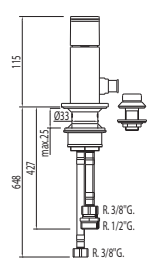

91.30.190

Cr

006.130.01



Monomando empotrar para bidé WC  
Ducha de latón con racord limitador 5 l/m. Antigoteo y flexo SATIN

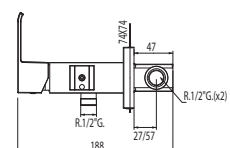

LATÓN



91.30.190

Cr

006.123.01

Cr

006.123.02 \*

\* Opción para paredes de Pladur

# SLIM-TRES

## Monomando baño

Ref.:

N

**Monomando ducha**  
(Ducha anticalcárea (202.639.01) y flexo SATIN (91.34.609.15)).

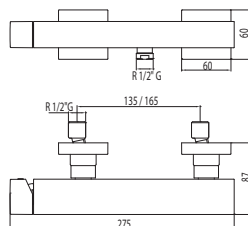

LATÓN



91.30.190

Cr

202.167.01

N

**Monomando bañera-ducha**  
(Ducha anticalcárea (202.639.01) y flexo SATIN (91.34.609)).

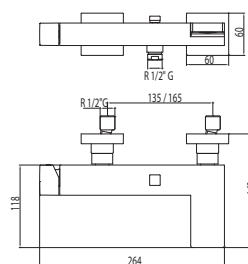

LATÓN



91.30.190

Cr

202.170.01

## Empotrados

Ref.:

N

**Monomando empotrar ducha**

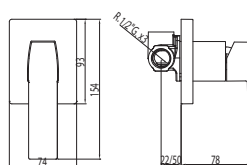

91.30.190

Cr

202.177.02



91.30.190

Cr

202.177.01

N

**Monomando empotrar baño-ducha**

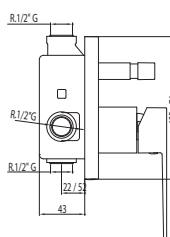

91.30.190

Cr

202.180.02



91.30.190

Cr

202.180.01

Cr = Cromo

Conjuntos empotrados

Ref.:



N

Kit de ducha monomando empotrado SLIM

con cierre y regulación de caudal. Ducha fija 320x220 mm. (299.632.02). Soporte con toma pared. (91.06.182). Ducha móvil anticalcárea. (202.639.01). Flexo SATIN (91.34.609.15).

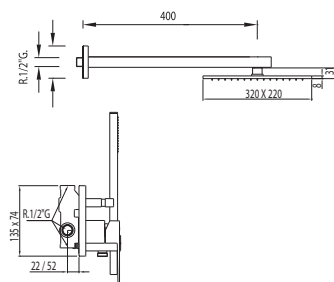

LATÓN



LATÓN



91.30.190

Cr

202.180.06



N

Kit de ducha monomando empotrado SLIM

con cierre y regulación de caudal. Ducha INOX 160x550 mm. (299.903.03). Soporte con toma pared. (91.06.182). Ducha móvil anticalcárea. (202.639.01). Flexo SATIN (91.34.609.15).

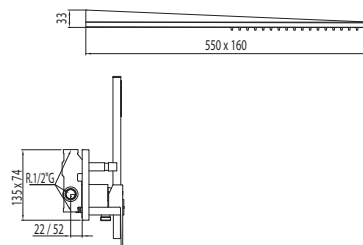

LATÓN



91.30.190

Cr

202.180.03



N

Kit de ducha monomando empotrado SLIM

con cierre y regulación de caudal. Ducha INOX con cascada 140x203 mm. (299.903.04). Soporte con toma pared. (91.06.182). Ducha móvil anticalcárea. (202.639.01). Flexo SATIN (91.34.609.15).

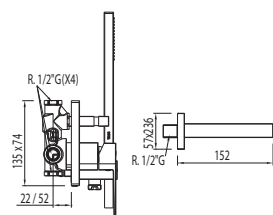

LATÓN



91.30.190

Cr

202.180.05

Cr = Cromo

# SLIM-TRES

Ref.:



**N**

**Kit de ducha monomando empotrado SLIM**  
 con cierre y regulación de caudal. Ducha fija 320x220 mm. (299.632.02).  
 Barra deslizante long. 900 mm. (1.34.520). Codo toma pared (91.06.182).  
 Ducha móvil anticalcárea. (202.639.01). Flexo SATIN (91.34.609.15).

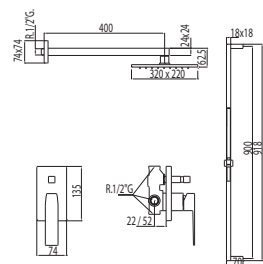

LATÓN



LATÓN



91.30.190

Cr

202.180.07



**N**

**Kit de ducha monomando empotrado SLIM**  
 con cierre y regulación de caudal. Ducha INOX con cascada 280x550 mm.  
 2 funciones (299.903.01).

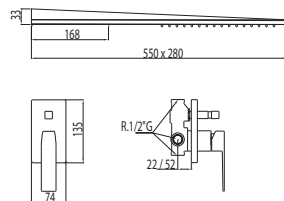

91.30.190

Cr

202.180.08

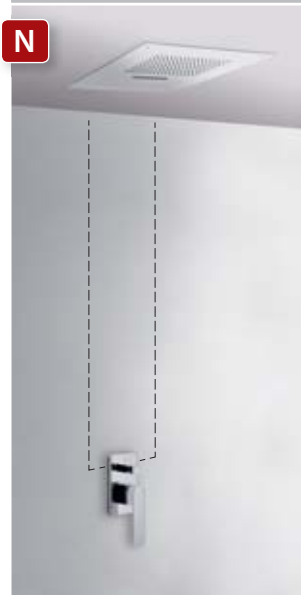

**N**

**Kit de ducha monomando empotrado SLIM**  
 con cierre y regulación de caudal. Ducha INOX con cascada 500x500 mm.  
 2 funciones (299.516.02)

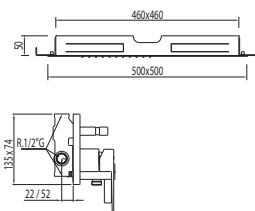

91.30.190

Cr

202.180.09

Cr = Cromo





# SLIM-TRES

## Termostáticas

Ref.:



**Ducha SLIM termostática**  
Ducha anticálrea con soporte orientable. Flexo SATIN (91.34.609.15).

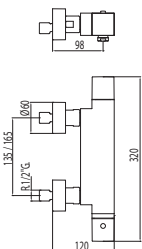

Cr

1.07.164



TRES TOUCH-COOL®



N

Cr

202.164.09



LATÓN



**Bañera-ducha SLIM termostática**  
con cascada. Ducha anticálrea con soporte orientable. Flexo SATIN (91.34.609).

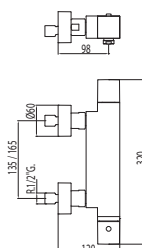

Cr

1.07.174



TRES TOUCH-COOL®



N

Cr

202.174.09



LATÓN

N



**Codo adaptador baño-ducha**

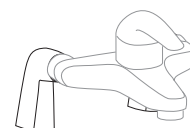
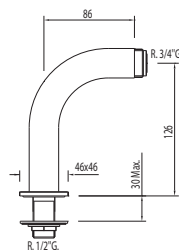

Con silenciador

Cr

299.870.02

## Conjuntos termostáticos

Ref.:

N



**Conjunto ducha SLIM termostática**  
Ducha fija 320x220 mm. Material Latón (299.632.02). Ducha móvil anticálrea (202.639.01) y flexo SATIN (91.34.609.15). Inversor integrado en el regulador de caudal (ver pág. 576)

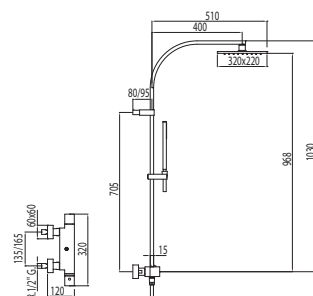

LATÓN



LATÓN



TRES TOUCH-COOL®

Cr

202.195.01

Cr = Cromo

Ref.:



**Kit de ducha termostático empotrado SLIM-CUADRO**  
con cierre y regulación de caudal. (2 vías) Ducha INOX con cascada 280x550 mm.  
2 funciones (299.903.01)

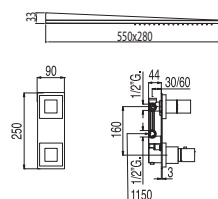

Cr 202.865.01



**Kit de ducha termostático empotrado SLIM-CUADRO**  
con cierre y regulación de caudal. (2 vías) Ducha INOX con cascada 500x500 mm.  
2 funciones (299.516.02)

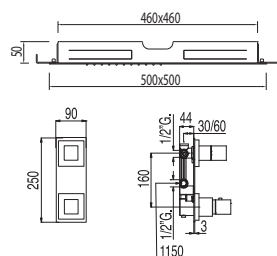

Cr 007.865.01



**Kit de ducha termostático empotrado SLIM**  
con cierre y regulación de caudal. (2 vías) Ducha fija 320x220 mm. (299.632.02).  
Material Latón. Soporte con toma pared. (91.06.182). Ducha móvil anticalcárea.  
(202.639.01). Flexo SATIN (91.34.609.15).

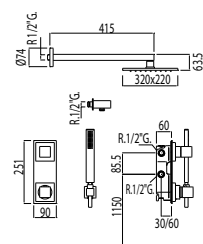

LATÓN



LATÓN

Cr 202.175.01

Cr = Cromo

# SLIM-TRES

Ref.:



N

**Kit de ducha termostático empotrado SLIM**  
 con cierre y regulación de caudal. (2 vías) Ducha INOX 210x550 mm.  
 (299.903.02). Soporte con toma pared. (91.06.182). Ducha móvil anticalcárea.  
 (202.639.01). Flexo SATIN (91.34.609.15).

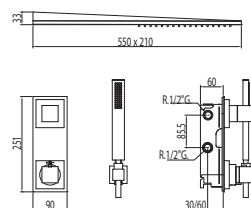

Cr 202.250.05



N

**Kit de ducha termostático empotrado SLIM**  
 con cierre y regulación de caudal. (2 vías) Ducha INOX 140x203 mm.  
 (299.903.04). Soporte con toma pared. (91.06.182). Ducha móvil anticalcárea.  
 (202.639.01). Flexo SATIN (91.34.609.15).

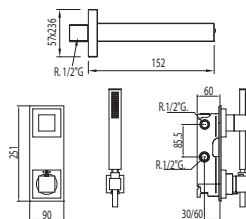

Cr 202.250.12



N

**Kit de ducha termostático empotrado SLIM**  
 con cierre y regulación de caudal. (3 vías) Ducha INOX con cascada 280x550 mm.  
 2 funciones (299.903.01). Soporte con toma pared. (91.06.182). Ducha móvil  
 anticalcárea. (202.639.01). Flexo SATIN (91.34.609.15).

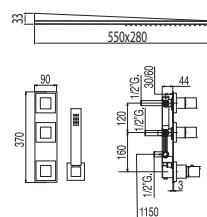

Cr 202.866.01

Cr = Cromo

Ref.:



N

**Kit de ducha termostático empotrado SLIM**

con cierre y regulación de caudal. (3 vías) Ducha INOX 210x550 mm. (299.903.02). 4 jets antical orientables (299.515.01). Soporte con toma pared. (91.06.182). Ducha móvil anticalcárea. (202.639.01). Flexo SATIN (91.34.609.15).

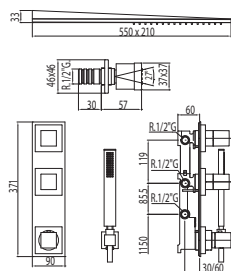

LATÓN

Cr 202.867.01



N

**Kit de ducha termostático empotrado SLIM**

con cierre y regulación de caudal. (4 vías) Ducha INOX con cascada 280x550 mm. 2 funciones (299.903.01). 4 jets antical orientables (299.515.01). Soporte con toma pared. (91.06.182). Ducha móvil anticalcárea. (202.639.01). Flexo SATIN (91.34.609.15).

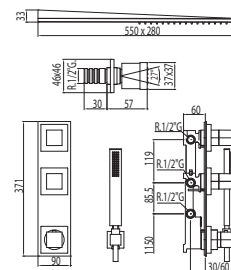

LATÓN

Cr 202.250.09



N

**Kit de ducha termostático empotrado SLIM**

con cierre y regulación de caudal. (3 vías) Ducha INOX con cascada 500x500 mm. 2 funciones (299.516.02). 4 jets antical orientables (299.515.01). Soporte con toma pared. (91.06.182). Ducha móvil anticalcárea. (202.639.01). Flexo SATIN (91.34.609.15).

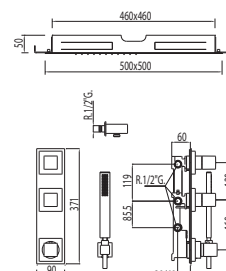

LATÓN

Cr 202.866.02

Cr = Cromo

# SLIM-TRES

Ref.:

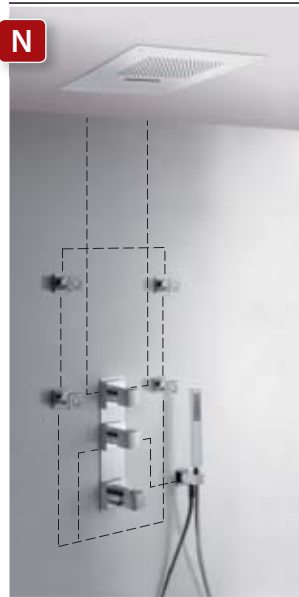

## Kit de ducha termostático empotrado SLIM

con cierre y regulación de caudal. (4 vías) Ducha INOX con cascada 500x500 mm. 2 funciones (299.516.02). 4 jets antical orientables (299.515.01). Soporte con toma pared. (91.06.182). Ducha móvil anticalcárea. (202.639.01). Flexo SATIN (91.34.609.15).

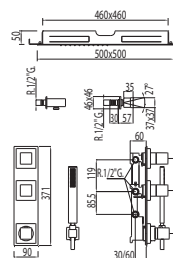

LATÓN

Cr 202.867.02



## Termostática bañera SLIM

con caño cascada. Soporte con toma pared. (91.06.182). Ducha móvil anticalcárea. (202.639.01). Flexo SATIN (91.34.609).



TRES BLOCK-SYSTEM®

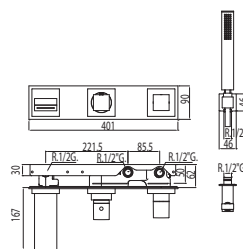

LATÓN

Cr 202.250.10



## Caño cascada bañera-ducha

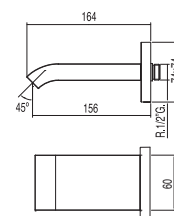

Cr 1.07.181  
Ac 5.07.181.03

## Elementos de ducha

Barra deslizante SLIM-CUADRO

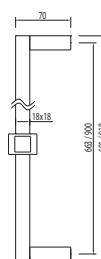

(663 mm.)

Cr	1.07.922	
	(900 mm.)	
Cr	1.34.520	

Kit anticalcárea SLIM-CUADRO

Latón. Ducha móvil anticalcárea (202.639.01) y flexo SATIN (91.34.609).

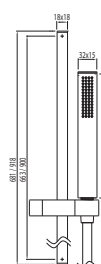

(663 mm.)

<b>N</b> Cr	034.336.03	
	(900 mm.)	
<b>N</b> Cr	034.336.04	

**N**

Conjunto ducha anticalcárea SLIM

Ducha fija 320x220 mm. (299.632.02). Ducha móvil anticalcárea (202.639.01) y flexo SATIN (91.34.609.15). Adaptable a grupo de ducha y baño-ducha.

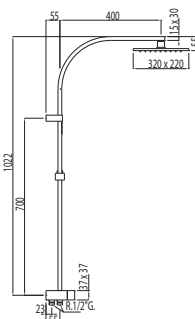
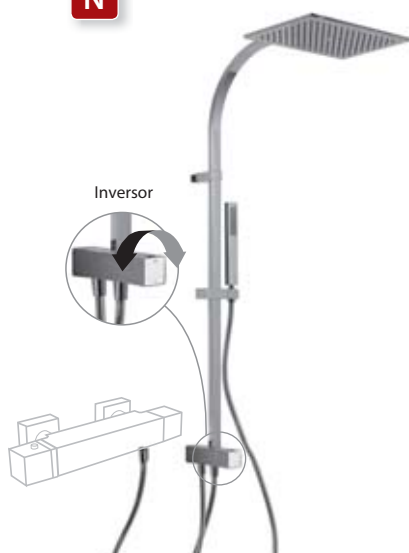

Cr	202.926.01	
----	------------	--

**N**

Conjunto ducha anticalcárea SLIM

Ducha fija 320x220 mm. (299.632.02). Ducha móvil anticalcárea (202.639.01) y flexo SATIN (91.34.609.15) con toma de agua inferior

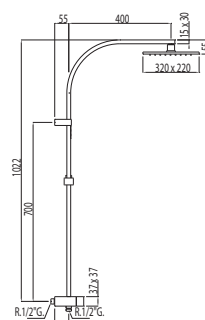
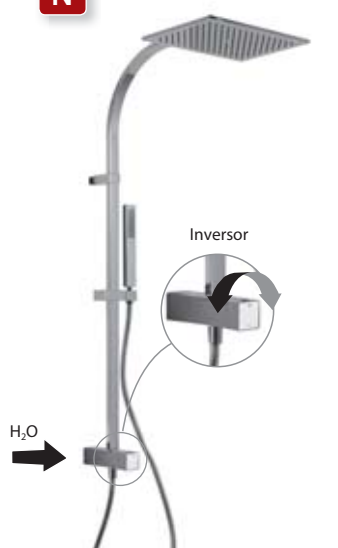

Cr	202.131.01	
----	------------	--

Cr = Cromo

# SLIM-TRES

## Llaves de paso

Ref.:



Llave de paso 1/2"

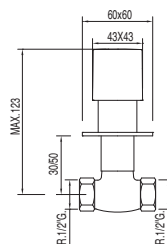

Cr 1.07.155



Llave de paso 3/4"

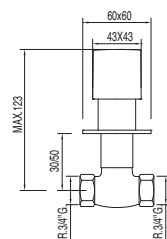

Cr 1.07.511

## Recambios

Maneta



Cr 299.083.10

Volante

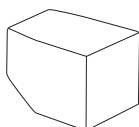

Cr 299.082.10

Volante lado caudal

(para ref.: 07.164, 07.174, 202.195.01, 202.164.09, 202.174.09)

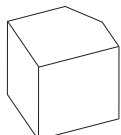

Cr 91.94.006.02

Volante lado caudal 2 salidas

(para ref.: 202.195.01)

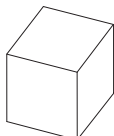

Cr 91.94.006.20

Volante lado temperatura

(para ref.: 07.164, 07.174, 202.195.01, 202.164.09, 202.174.09)

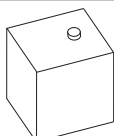

Cr 91.94.006.01

Cartucho termostático + volante

(para ref.: 07.164, 07.174, 202.195.01, 202.164.09, 202.174.09)



Cr 91.06.161.01

Base grifos

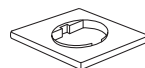

Cr 299.081.01

Rótula bidé completa + llave



Cr 91.07.672

Inversor

(para ref.: 202.180.01, 202.180.02)

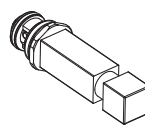

Cr 91.06.180.20

Rompeaguas oculto + llave

M. 24

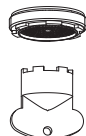

Cr 91.34.668

Desagüe automático

1,1/4"

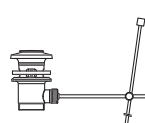

Cr 91.34.375.10

Conjunto varilla y pulsador



Cr 91.34.375

Cr = Cromo